

**SCHEMAT PODŁĄCZENIA
WTRYSKIWACZY (STRONA 2)
INJECTORS CONNECTION
DIAGRAM (PAGE 2)**

DO STEROWNIKA BENZYNOWEGO
TO PETROL ECU

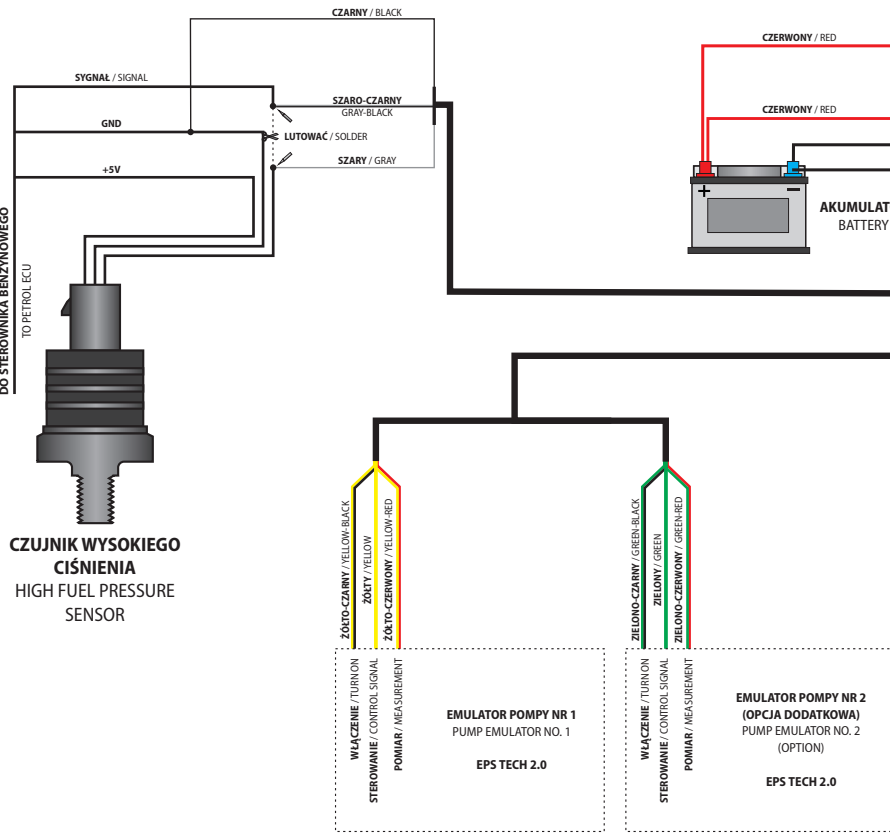

CZUJNIK WYSOKIEGO CIŚNIENIA / HIGH FUEL PRESSURE SENSOR

ŻÓŁTO-CZARNY / YELLOW-BLACK
ŻÓŁTY / YELLOW
ŻÓŁTO-CZERWONY / YELLOW-RED

ZIELONO-CZARNY / GREEN-BLACK
ZIELONY / GREEN
ZIELONO-CZERWONY / GREEN-RED

STACYJKA / IGNITION SWITCH

PRZEŁĄCZNIK BENZYNY/GAZ / PETROL/GAS SWITCH

GNAZDO OBD / OBD SOCKET

BIAŁY / WHITE - CAN H (6)
ZIELONY / GREEN - CAN L (14)

BIAŁY / WHITE / CZERWONY / RED
CZARNY / BLACK

CZUJNIK POŁOŻENIA WAŁKA ROZRZĄDU (EWENTUALNIE CEWKA) / CAMSHAFT POSITION SENSOR (OR IGNITION COIL)



BRĄZOWY / BROWN

WŁĘCIE ANALOGOWE / ANALOG INPUT
FIOLETOWY / PURPLE

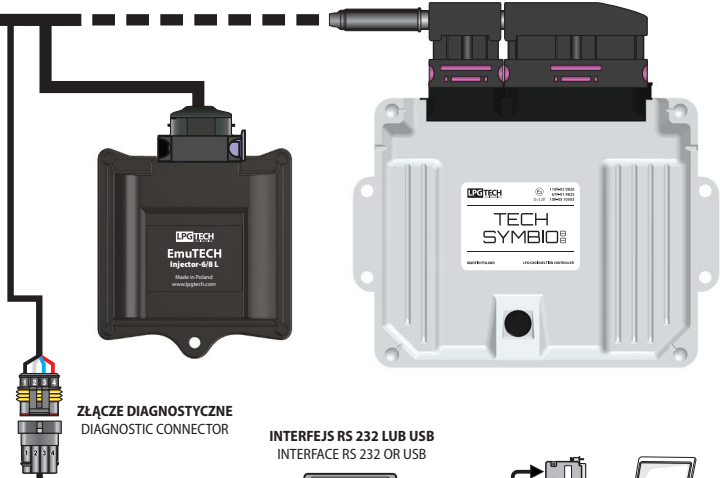

UWAGA / CAUTION
Do aktualizacji firmware sterownika należy użyć przewodowego interfejsu OptoTECH.
To update controller firmware use OptoTECH communication module.

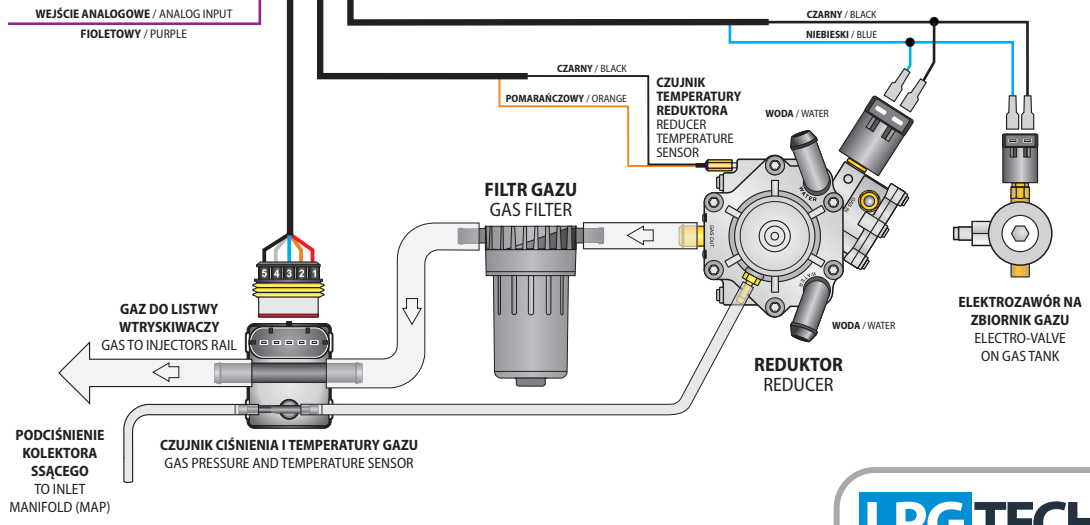
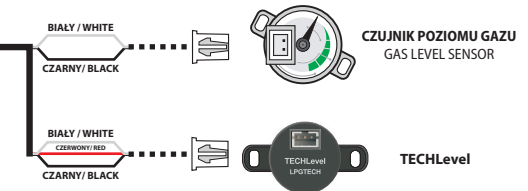

TECH SYMBIO 6/8

LPGTECH
GAS INNOVATIONS

**STEROWNIK BENZYNOWY
PETROL ECU**

**WTRYSKIWACZE BEZPOŚREDNIE BENZYNY 1-8
PETROL DIRECT INJECTORS 1-8**

WTRYSKIWACZ 1 GÓRA
INJECTOR 1 HIGH

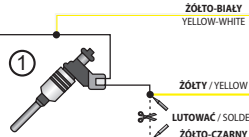

WTRYSKIWACZ 1 DÓŁ
INJECTOR 1 LOW



WTRYSKIWACZ 2 GÓRA
INJECTOR 2 HIGH

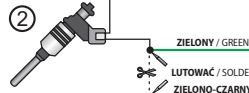

WTRYSKIWACZ 2 DÓŁ
INJECTOR 2 LOW



WTRYSKIWACZ 3 GÓRA
INJECTOR 3 HIGH

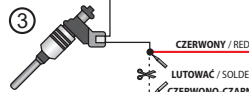

WTRYSKIWACZ 3 DÓŁ
INJECTOR 3 LOW



WTRYSKIWACZ 4 GÓRA
INJECTOR 4 HIGH

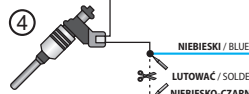

WTRYSKIWACZ 4 DÓŁ
INJECTOR 4 LOW



WTRYSKIWACZ 5 GÓRA
INJECTOR 5 HIGH

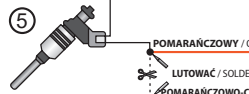

WTRYSKIWACZ 5 DÓŁ
INJECTOR 5 LOW



WTRYSKIWACZ 6 GÓRA
INJECTOR 6 HIGH

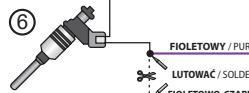

WTRYSKIWACZ 6 DÓŁ
INJECTOR 6 LOW



WTRYSKIWACZ 7 GÓRA
INJECTOR 7 HIGH

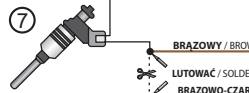

WTRYSKIWACZ 7 DÓŁ
INJECTOR 7 LOW



WTRYSKIWACZ 8 GÓRA
INJECTOR 8 HIGH

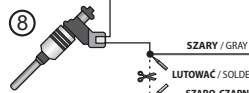

WTRYSKIWACZ 8 DÓŁ
INJECTOR 8 LOW



**STEROWNIK BENZYNOWY
PETROL ECU**

**WTRYSKIWACZE POŚREDNIE BENZYNY 1-8
PETROL INDIRECT INJECTORS 1-8**

WTRYSKIWACZ 1 SYGNAŁ
INJECTOR 1 SIGNAL

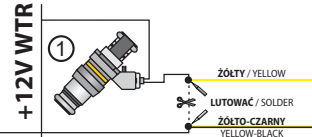

WTRYSKIWACZ 2 SYGNAŁ
INJECTOR 2 SIGNAL

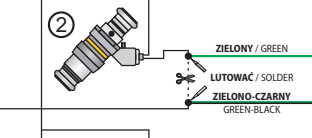

WTRYSKIWACZ 3 SYGNAŁ
INJECTOR 3 SIGNAL

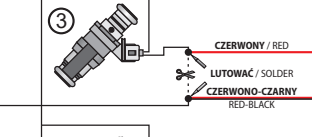

WTRYSKIWACZ 4 SYGNAŁ
INJECTOR 4 SIGNAL

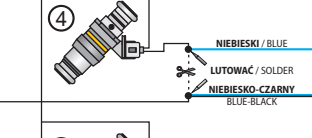

WTRYSKIWACZ 5 SYGNAŁ
INJECTOR 5 SIGNAL

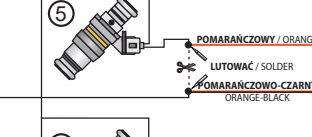

WTRYSKIWACZ 6 SYGNAŁ
INJECTOR 6 SIGNAL

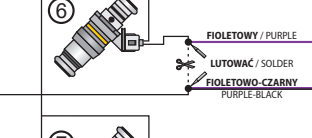

WTRYSKIWACZ 7 SYGNAŁ
INJECTOR 7 SIGNAL

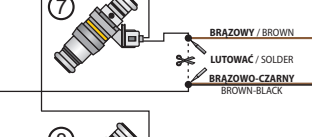

WTRYSKIWACZ 8 SYGNAŁ
INJECTOR 8 SIGNAL

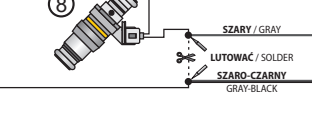

**SCHEMAT PODŁĄCZENIA
WTRYSKIWACZY
INJECTORS CONNECTION
DIAGRAM**

**WTRYSKIWACZE GAZU 1-8
GAS INJECTORS 1-8**

